

**STRAIGHT JACK CRIMP TYPE**

**R125.225.901**

**CABLE .141**

Series : SMA

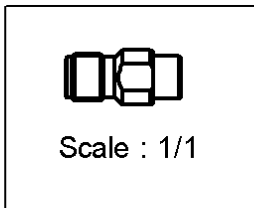
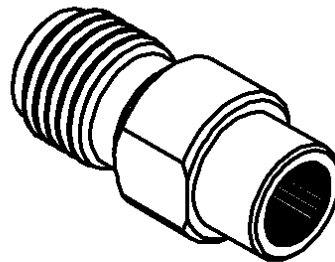
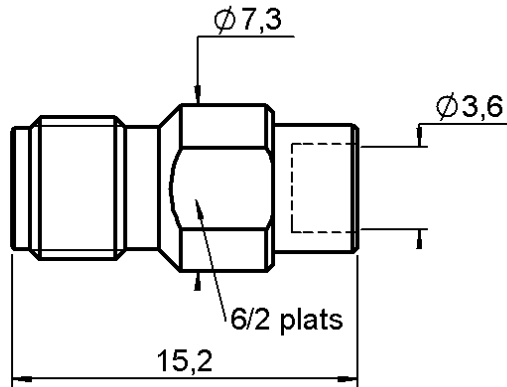

All dimensions are in mm.



COMPONENTS	MATERIALS	PLATINGS ( $\mu\text{m}$ )
BODY	STAINLESS STEEL	PASSIVATED .
CENTER CONTACT	BERYLLIUM COPPER	GOLD 1.3 OVER NICKEL 2
OUTER CONTACT	-	-
INSULATOR	PTFE	-
GASKET	-	-
OTHERS PARTS	STAINLESS STEEL	PASSIVATED .
-	-	-
-	-	-

Issue : 0622 C

In the effort to improve our products, we reserve the right to make changes judged to be necessary.



**STRAIGHT JACK CRIMP TYPE**

**R125.225.901**

**CABLE .141**

Series : SMA

**PACKAGING**

Standard	Unit	Other
<b>100</b>	<b>'W' option</b>	<b>Contact us</b>

**SPECIFICATION**

**CABLE ASSEMBLY**

**ELECTRICAL CHARACTERISTICS**

Stripping	a	b	c	d	e	f
mm	2,16	0,00	0,00	0,00	0,00	0,00

Impedance	<b>50</b>	$\Omega$
Frequency	<b>0-18</b>	GHz
VSWR	<b>1.05 + 0,0100</b>	x F(GHz) Maxi
Insertion loss	<b>0.03</b>	$\sqrt{F}$ (GHz) dB Maxi
RF leakage	- ( <b>60</b> )	- F(GHz) dB mini
Voltage rating	<b>500</b>	Veff Maxi
Dielectric withstanding voltage	<b>1000</b>	Veff mini
Insulation resistance	<b>5000</b>	M $\Omega$ mini

Assembly instruction :

Recommended cable(s)  
RG 402  
KS 2

Cable retention

- pull off **270** N mini
- torque **NA** N.cm

**MECHANICAL CHARACTERISTICS**

**TOOLING**

Center contact retention		
Axial force – Mating end	<b>27</b>	N mini
Axial force – Opposite end	<b>27</b>	N mini
Torque	<b>2.8</b>	N.cm mini

Part Number	Description	Hexagon
.	.	.
R282.286.000	CRIMPING TOOL	-
R282.703.000	POSITIONER	-
R282.053.000	STRIPPING TOOL	
R282.066.000	POINTER GAUGE	
R282.711.000	GUIDE	

Recommended torque		
Mating	<b>NA</b>	N.cm
Panel nut	<b>NA</b>	N.cm
Clamp nut	<b>NA</b>	N.cm
A/F clamp nut	<b>0,0000</b>	mm

**OTHERS CHARACTERISTICS**

Mating life	<b>500</b>	Cycles mini
Weight	<b>2,7000</b>	g

**ENVIRONMENTAL**

Operating temperature	<b>-65/+105</b>	$^{\circ}$ C
Hermetic seal	<b>NA</b>	Atm.cm3/s
Panel leakage	<b>NA</b>	

Issue : 0622 C

In the effort to improve our products, we reserve the right to make changes judged to be necessary.



**STRAIGHT JACK CRIMP TYPE**

**R125.225.901**

**CABLE .141**

Series : SMA

**COMPONENTS**

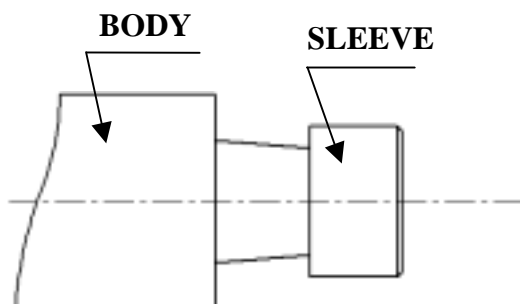

**STIPPING DIMENSIONS**

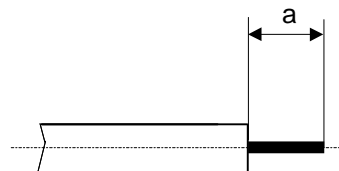

1

- Strip the cable with the cable stripping tool
- Trim the cable inner conductor with the trimmer.

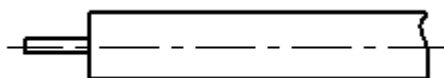

3

- Insert the connector and the cable on the crimping tool with guide and positioner.
- A pneumatic crimping tool exist too that can be used

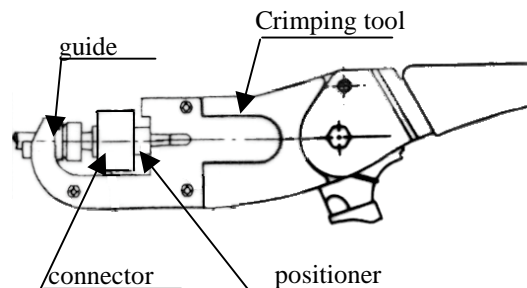

2

- Slide connector onto the cable

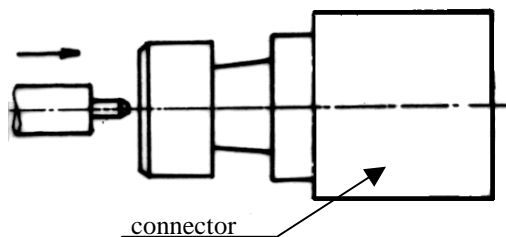

4

- Press the connector on the cable.

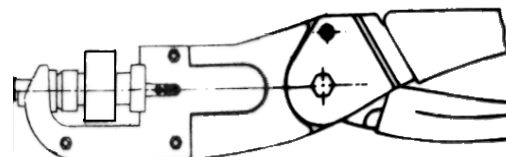

Issue : 0622 C

In the effort to improve our products, we reserve the right to make changes judged to be necessary.

